

AFX

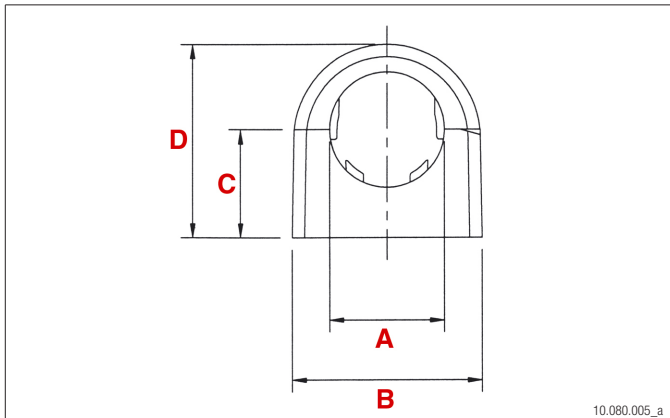

MAT PA 6.6, mod. Nylon

RoHS

TEMP -40°C bis +120°C
-40°C à +120°C
-40°C to +120°C

HALO halogenfrei
sans halogène
halogen free

 nicht ausbreitend UL 94 V2
non propagateur UL 94 V2
no propagator UL 94 V2

UV UV-beständig
UV-résistant
UV-resistant

Schlauchhalter AFX

















Der ideale Halter für Wellschläuche, schnelle Montage durch Einlochbefestigung. Zugentlastung und integrierter Schliessbügel für sichere und formschöne Halterung, einteilig.

Support de gaine AFX

Idéal pour toutes les gaines rainurées, montage simple par un trou de vis. Ancrage par des ergots et clip de fermeture intégrés, en une pièce.

Conduit holder AFX

For corrugated conduits, single hole for easy installation. Excellent strain relief and integrated security lid, on one piece.

NORM NW/DN	A mm	B mm	C mm	D mm		Plica-Nr.	E-Nr.	VE
7	10.0	22.6	12.9	23.3		80.8205.307	126 140 000	10
						80.8205.207	126 140 009	10
10	13.0	22.6	12.9	23.3		80.8205.310	126 140 100	10
						80.8205.210	126 140 109	10
12	15.8	26.7	15.1	26.9		80.8205.312	126 140 200	10
						80.8205.212	126 140 209	10
17	21.2	33.8	19.5	34.9		80.8205.317	126 140 400	10
						80.8205.217	126 140 409	10
23	28.5	43.8	23.4	43.7		80.8205.323	126 140 500	10
						80.8205.223	126 140 509	10
29	34.5	52.8	26.9	51.6		80.8205.329	126 140 600	10
						80.8205.229	126 140 609	10
36	42.5	64.5	32.4	62.5		80.8205.336	126 140 700	10
						80.8205.236	126 140 709	10
48	54.5	81.0	38.5	77.0		80.8205.348	126 140 800	10
						80.8205.248	126 140 809	10