

FLAKA K PA GFK (metr.)

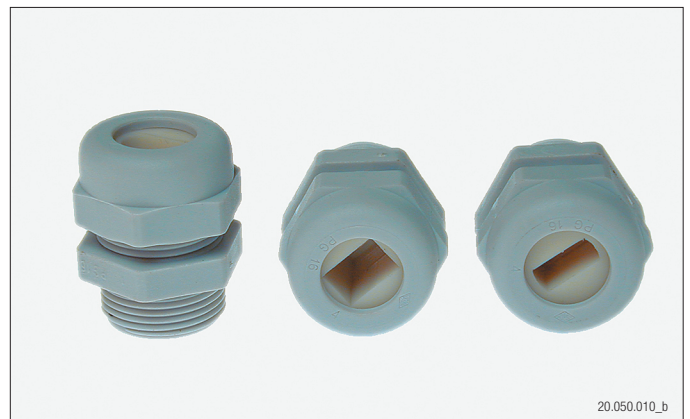
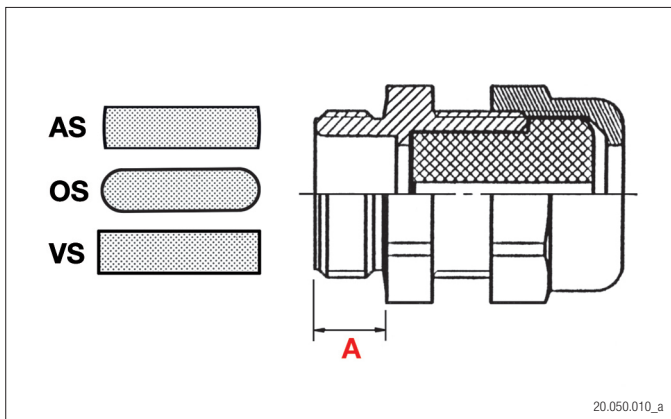

MAT PA 6 / GFK 25%
PA 6 / F.V. 25%
PA 6 / F.G. 25%

RoHS

TEMP -30°C bis +120°C
-30°C à +120°C
-30°C to +120°C

IP 68 bis 5 bar
IP 68 à 5 bar
IP 68 to 5 bar

Tefabloc 60 SH A
Tefabloc 60 Sh A
Tefabloc 60 Sh A

HALO halogenfrei
sans halogène
halogen free

NORM EN 60423

Flachkabelverschraubung FLAKA K PA GFK
Formschöne Kabelverschraubung in Polyamid mit grossem Klemmbereich für Flachkabel.

Presse-étoupe pour câble plat FLAKA K PA GFK
Presse-étoupe élégant en polyamide avec grande gamme de serrage pour câble plat.

Cable gland for flat cables FLAKA K PA GFK
Good looking cable gland in polyamide with wide clamping range for flat cables.































	$> Ø <$ mm	A mm			Plica-Nr.	E-Nr.	VE
AS: Mit abgerundetem Schlitzloch			AS: Avec ouverture à fente arrondie		AS: With rounded hole		
M16	3.5x5.5	8	19		90.5107.160	121 680 403	50
M20	3x12	9	24		90.5107.200	121 680 503	50
	5x11	9	24		90.5107.201	121 680 513	50
	5x12	9	27		90.5107.202	121 680 523	50
	7.5x14	9	27		90.5107.203	121 680 533	50
M25	5x16	11	33		90.5107.250	121 680 603	20
	5x17	11	33		90.5107.251	121 680 613	20
	7x18	11	33		90.5107.252	121 680 623	20
	9x15	11	33		90.5107.253	121 680 633	20
M32	8x25	12	42		90.5107.320	121 680 703	20
	10x25	12	42		90.5107.321	121 680 713	20
M40	6x29	15	55		90.5107.400	121 680 803	20
	6x30	15	55		90.5107.401	121 680 813	20
	6x36	15	55		90.5107.402	121 680 823	20
	8x36	15	55		90.5107.403	121 680 833	200
	11x34	15	55		90.5107.404	121 680 843	20
	12x35	15	55		90.5107.405	121 680 853	20
	13x28	15	55		90.5107.406	121 680 863	20
M50	10x38	15	65		90.5107.501	121 680 903	10
	13x35	15	65		90.5107.502	121 680 913	10

Technische Änderungen vorbehalten – Sous réserve de changements techniques – Technical alterations reserved

Kabelverschraubungen
Flachkabel Kunststoff metr.

Presse-étoupes
Câble plat plastique métr.

Cable glands
Flat cable plastic metr.

	$> \varnothing <$ mm	A mm	 mm		Plica-Nr.	E-Nr.	VE
M50	14x37	15	65		90.5107.503	121 680 923	10
M63	6.5x47	15	70		90.5107.630	121 680 943	5
	9x43	15	70		90.5107.631	121 680 953	5
	14.5x39	15	70		90.5107.632	121 680 963	5
	15x45	15	70		90.5107.633	121 680 973	5
OS: Mit ovalem Schlitzloch			OS: Avec ouverture à fente ovale		OS: With oval hole		
M20	5x8	9	24		90.5108.200	121 681 503	50
	5x12	9	24		90.5108.201	121 681 513	50
	5.5x8.5	9	27		90.5108.202	121 681 523	50
	7x14	9	27		90.5108.203	121 681 533	50
M25	5x15	11	33		90.5108.250	121 681 603	20
	5x16	11	33		90.5108.251	121 681 613	20
	6x15	11	33		90.5108.252	121 681 623	20
	7x16.5	11	33		90.5108.253	121 681 633	20
M32	7x20	12	42		90.5108.320	121 681 703	20
M40	6.5x32	15	55		90.5108.400	121 681 803	20
	10x27	15	55		90.5108.401	121 681 813	20
	11x35	15	55		90.5108.402	121 681 823	20
M50	6x41	15	65		90.5108.500	121 681 903	10
	9x38	15	65		90.5108.501	121 681 913	10
VS: Mit viereckigem Schlitzloch			VS: Avec ouverture à fente rectangulaire		VS: With rectangular hole		
M20	8x12	9	27		90.5109.200	121 682 503	50
M25	4x15	11	33		90.5109.250	121 682 603	20
M40	5x36	15	55		90.5109.400	121 682 803	20
	6x26	15	55		90.5109.401	121 682 813	20
	7x26	15	55		90.5109.402	121 682 823	20
	8x30	15	55		90.5109.403	121 682 833	20
M50	5.5x37	15	65		90.5109.500	121 682 903	10
	6x39	15	65		90.5109.501	121 682 913	10