

Raiden IP66 21KLM 840 Asymmetric Wide DALI

Code article 2824098

Concord



Outdoor and indoor floodlight range with in house design, comes complete with 1m flying lead and adjustable bracket, aluminium housing, RAL 9022 - Pearl light grey, clear glass diffuser, IP66, IK08, Class I, 4000K, DALI dimmable, 20200lm, 157W, 129lm/W, CRI80, Asymmetric Wide beam angle 110*50°, 100000 hrs L90B50 lifespan, 511x319x76mm (LxWxH) dimensions, 6.8kg weight. Ball-impact-resistance according to DIN57710-13 VDE 0710 13/5.81, DIN 18032-3 only with the separate wire guard accessory fitted.

Atouts techniques

Dimensions (mm)

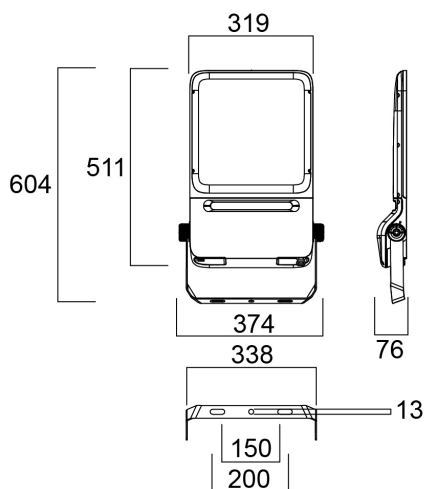

Photométrie

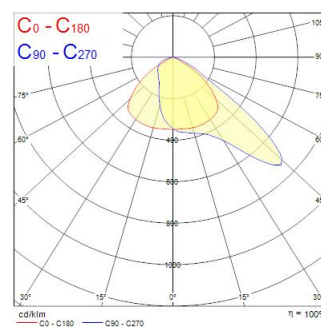

Raiden IP66 21KLM 840 Asymmetric Wide DALI

Code article 2824098

Concord

Données générales

Nom du produit	Raiden IP66 21KLM 840 Asymmetric Wide DALI
Technologie	LED
Cap/Base	N/A
Housing	Aluminium
General application	Logistics & Industry
Operating temperature range (°C)	-40°C...+50°C
Performance ambient temperature Tq (°C)	25
ETIM Class	EC001744
Warranty	5 ans

Données optiques

Fixture luminous flux (lm)	20200
Luminaire efficacy (lm/W)	129
Température de couleur (K)	4000
Couleur de lumière	Neutral White
IRC (Ra)	80
Colour Variation Initial (SDCM)	SDCM3
Beam Angle (°)	110*50
Photobiological Risk Group	RG1

Caractéristiques électriques

Consommation électrique totale (W)	157
Primary Supply/Product voltage - min (V)	220
Primary Supply/Product voltage - max (V)	240
Lamp power factor	0.95
THD (at 230 V, 50 Hz, full load, at 100% dimming level) ≤ xx.x %	20
Electrical protection	Class I
Control gear required	No
Dimmable	Yes
Dimming method	DALI-2
Drive current (mA)	3200
Courant d'appel (A)	125
Inrush Duration (µs)	200
Energy Efficiency Class (A->G) of contained light source	E
Nominal Frequency (Hz)	50/60Hz
Max. products per 10A C Breaker	6
Max. products per 13A C Breaker	5
Max. products per 16A C Breaker	6
Max. products per 20A C Breaker	8
Max. products per 10A B Breaker	3
Max. products per 13A B Breaker	3
Max. products per 16A B Breaker	3
Max. products per 20A B Breaker	4
Mains surge immunity (differential mode -> L-N) (kV)	6
Mains surge immunity (common mode -> L/N - GND) (kV)	10

Durée de vie

Lifespan L70 B50	100000
Lifespan L80 B20	94000
Lifespan L90 B50	100000

Raiden IP66 21KLM 840 Asymmetric Wide DALI

Code article 2824098

Concord

Données physiques

Housing colour	RAL 9022 - Pearl light grey
IP rating	IP66
IK rating	IK08
Longueur (mm)	511
Largeur (mm)	319
Nominal Product Height (mm)	76
Poids (kg)	6.8

Emballage

Product EAN number	5025768240982
Longueur simple de l'emballage (cm)	56.0
Largeur simple de l'emballage (cm)	41.5
Packaging single depth (cm)	14.0
DUN14 (inner)	05025768240982
Units per outer package	1
Packaging outer length / height (cm)	56.0
Packaging outer width (cm)	41.5
Packaging outer depth (cm)	14.0

Sécurité

Glow Wire Test (°C)	850
Condition de fonctionnement optimal (° C)	-40-50